

**AYDE**

**DİLATASYON PROFİLLERİ**

DILATATION PROFILES

**27000**

1,000 kg / mt

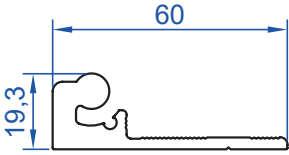

**27001**

1,298 kg / mt

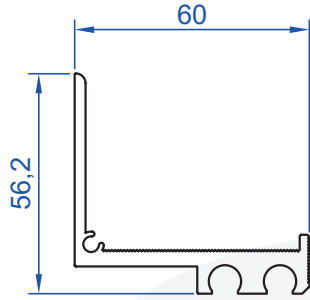

**27003**

0,821 kg / mt

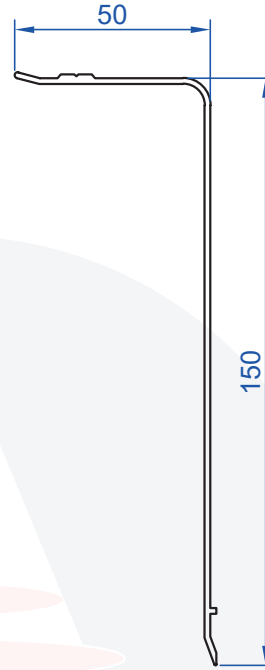

**27004**

0,493 kg / mt

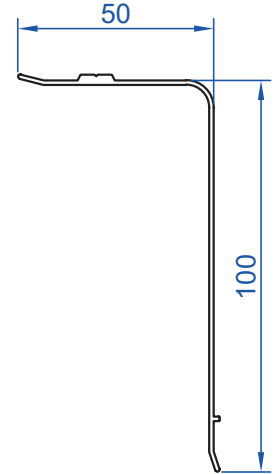

**27007**

1,050 kg / mt



**27006**

1,095 kg / mt

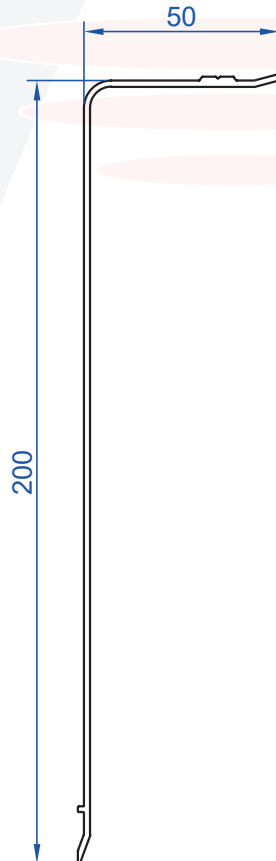

**27005**

0,675 kg / mt

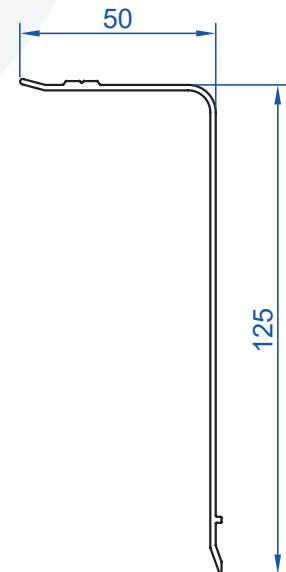

**27008**

0,845 kg / mt



**27009**

0,474 kg / mt



**27010**

0,485 kg / mt



**27011**

1,450 kg / mt

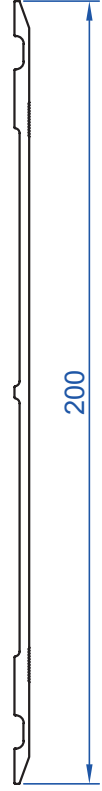

**27012**

0,789 kg / mt

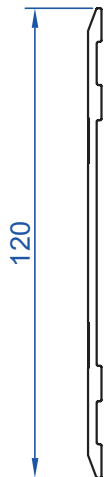

**27013**

0,659 kg / mt

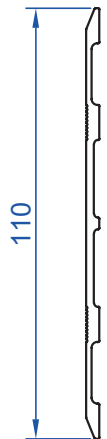

**27014**

0,997 kg / mt

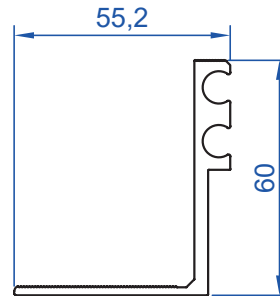

**27015**

0,377 kg / mt

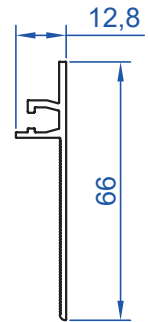

**27016**

0,333 kg / mt

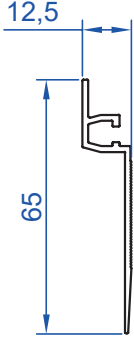

**27017**

0,265 kg / mt

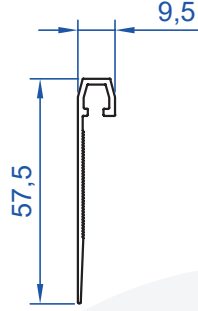

**27018**

1,268 kg / mt

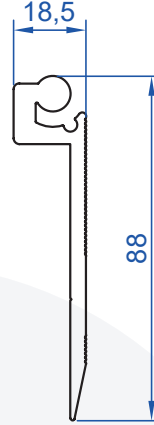

**27019**

2,626 kg / mt



**27020**

0,976 kg / mt



**27021**

3,512 kg / mt

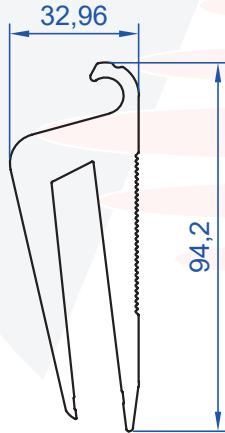

**27022**

1,880 kg / mt

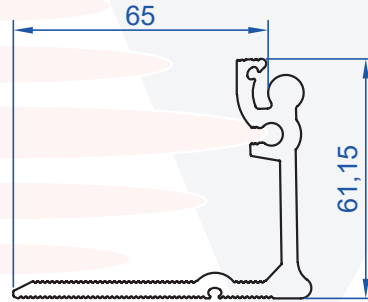

**27023**

0,290 kg / mt

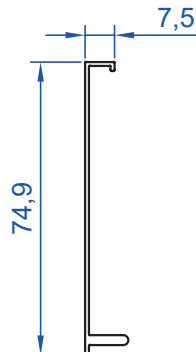

**27024**

0,279 kg / mt

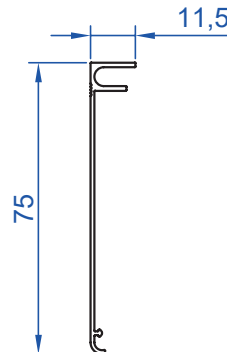

**27025**

0,846 kg / mt

